



# REAR AUX LIGHT KIT

## FOR CHEVY & GMC LD TRUCKS

### PLEASE READ ENTIRELY BEFORE YOU START

To guarantee a quality installation, we recommend reading these instructions thoroughly before beginning any work. These instructions assume a certain amount of mechanical ability and are not written nor intended for someone not familiar with auto repair.

INCLUDED PARTS	QTY	REQUIRED TOOLS
Aux Light Bracket RH	2	Common Hand Tools
Hardware Pack	1	

This bracket is designed for use with Baja Designs Squadron 3" Light, SKU 550006



1. Remove the Inner Bezel from the rear bumper by pulling it off (fig. 1).

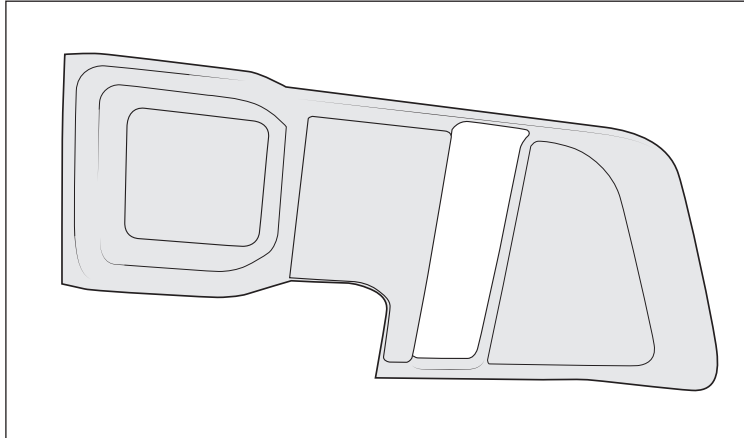

Figure 1

2. Remove the aux light cover via the clips on the backside of the bezel (fig. 2).

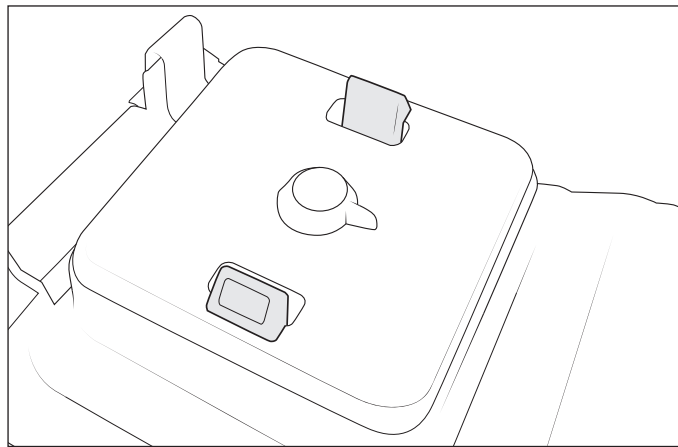

Figure 2

3. Trim the inner bezel along the line pictured below (fig. 3).

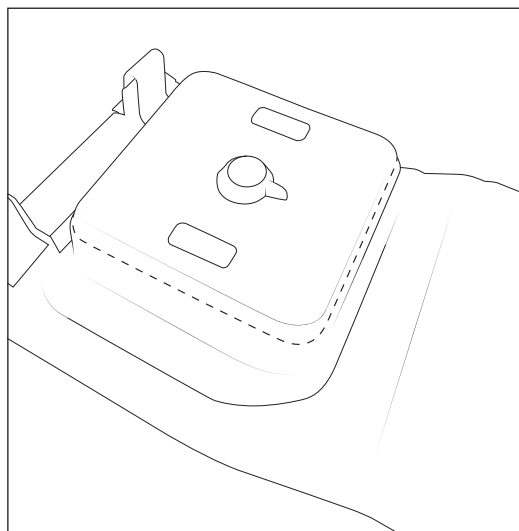
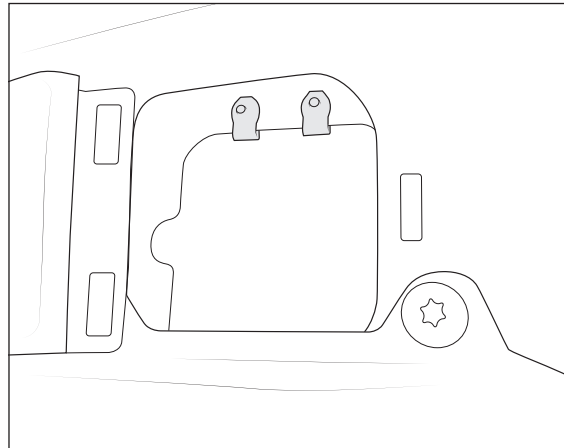

Figure 3



4. Insert the supplied U-Nuts into the bumper as shown (fig. 4).



*Figure 4*

5. Install the AEV bracket onto your desired light (fig. 5). NOTE: AEV recommends Baja Design Squadron 3" light (PN 550006).

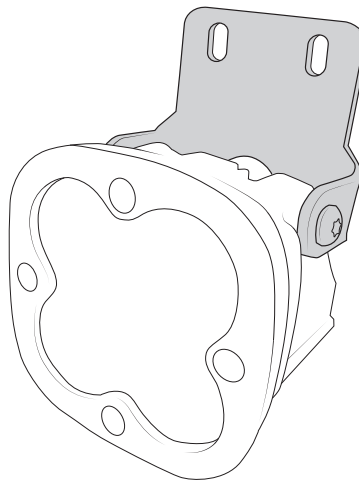

*Figure 5*

6. Using the provide screws, secure the light bracket to the bumper (fig. 6).

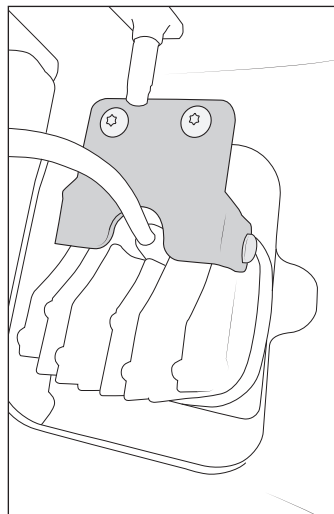

*Figure 6*



7. Press the inner bezel back into place ensuring each clip is secured (fig. 7).

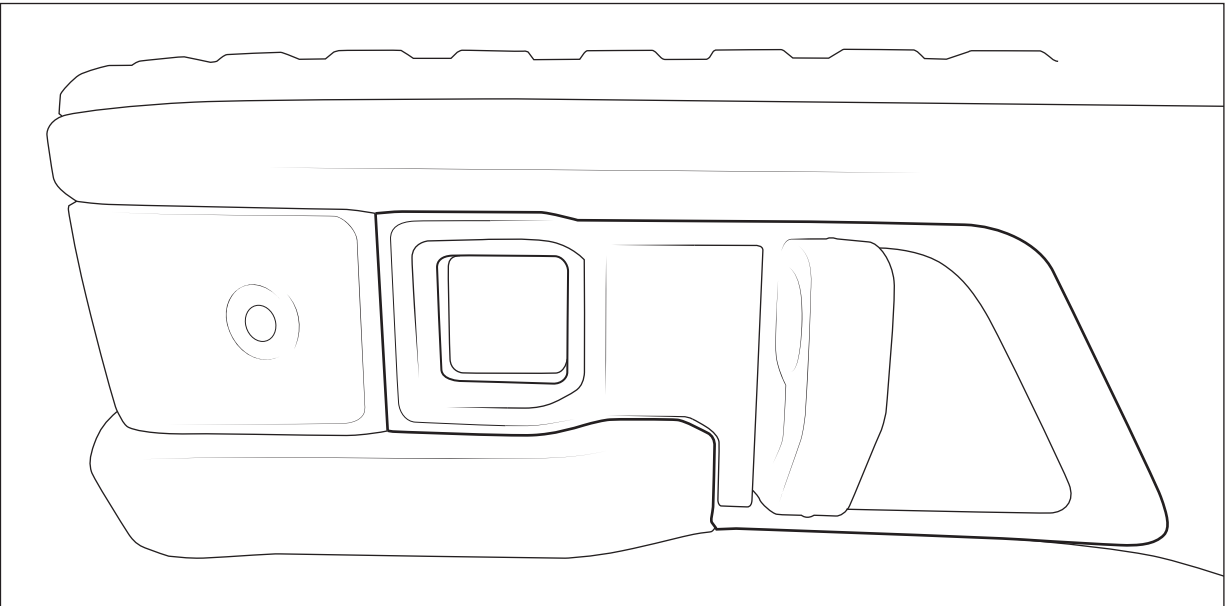

*Figure 7*