

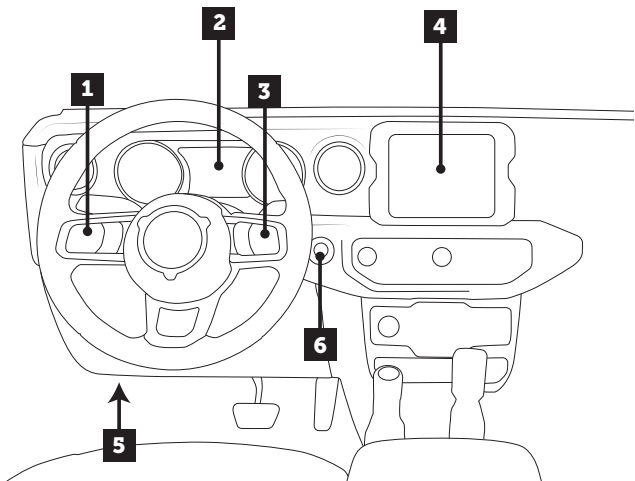

USER GUIDE | JL WRANGLER

AEV30348AA



1. INSTRUMENT CLUSTER DISPLAY CONTROL BUTTONS
2. INSTRUMENT CLUSTER DISPLAY
3. CRUISE CONTROL BUTTONS
4. STEREO DISPLAY
5. OBDII PORT
6. ENGINE START/STOP BUTTON

# OVERVIEW

The AEV ProCal SNAP is a simple, easy to use electronic recalibration module for 2018+ Jeep JL model Wranglers. ProCal SNAP has the ability to recalibrate your vehicle's speedometer to compensate for non-factory tire sizes, replacement axle gear ratios and aftermarket or different transfer case gear ratios by simply plugging into the OBDII diagnostic port and inputting the numerical values using the stereo's audio equalizer.

**PLEASE** read these instructions completely before attempting to use this module. Follow these order of operations:

1. Install the included **AEV JL ProCal Harness** (PN 30301046) using instructions from [aev-conversions.com](http://aev-conversions.com).
2. Pair ProCal SNAP to the vehicle.
3. Recalibrate vehicle with ProCal SNAP

**NOTE:** The ProCal SNAP does not record the changes into your vehicle's history with FCA/Jeep. Any Warranty or Recall that requires a re-programming of the modules may erase the ProCal SNAP settings and require you to use the ProCal SNAP to adjust your settings again.

# PAIR PROCAL SNAP TO VEHICLE

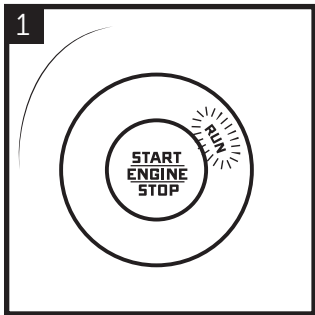

Press 2 times to put into the "RUN" position.

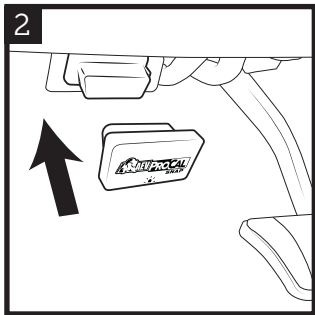

Insert ProCal SNAP into the OBDII port.

**NOTE:** The ProCal SNAP must be paired to a vehicle before it will recalibrate any settings. Once completed, the ProCal SNAP will be **permanently locked to this vehicle.**

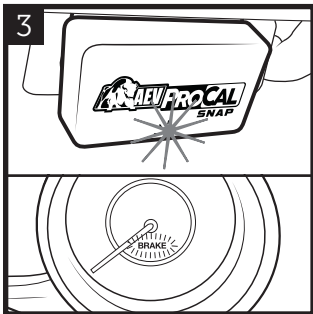

Wait for a blinking GREEN light on the SNAP and a blinking BRAKE light on the speedometer.

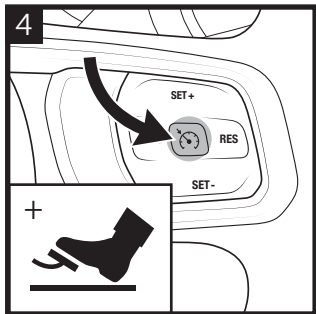

With your foot on the brake, PRESS and HOLD the CRUISE ON/OFF button for 3 SECONDS.

**5 HONK! HONK! HONK!** When the pairing process is complete, the horn will sound quickly 3 times. Your ProCal SNAP is now paired and ready to recalibrate your vehicle.

# PROGRAMMING VEHICLE

Once the pairing process has been completed, you are ready to recalibrate your vehicle. Use the following method to recalibrate **Tire Size**, **Axle Ratio**, or **Transfer Case Ratio**.

To recalibrate Tire Size: Begin by physically measuring your tire diameter IN INCHES from the ground to the top of front tire with the vehicle level and on the ground.

Recalibrating gear ratios is only necessary if you have physically changed the vehicle's axle gears or replaced the transfer case with a different ratio.

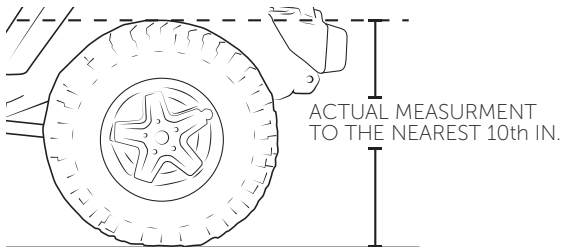

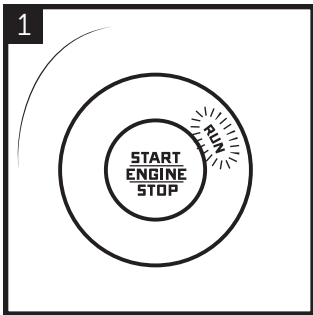

Press 2 times to put into the "RUN" position.

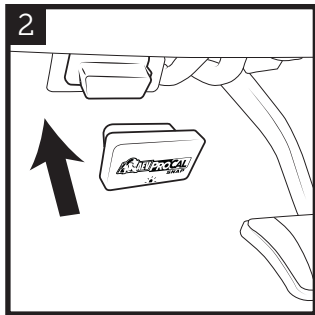

Insert ProCal SNAP into the OBDII port.

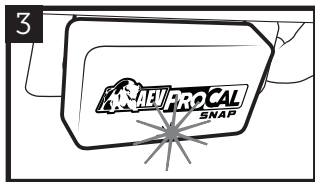

Wait for a solid GREEN light on the SNAP.

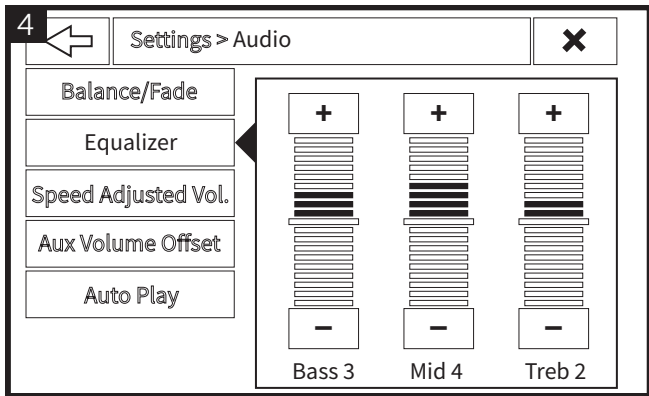

UCONNECT 4 and 4C *(Example A shown)*

Adjust the stereo's EQUALIZER SETTINGS to the values you wish to set.

- Example A: 34.2" Tires, Bass = 3, Mid = 4, Treb = 2.
- Example B: 4.10 Axle Ratio, Bass = 4, Mid = 1, Treb = 0.
- Example C: 3.80 T-Case Ratio, Bass = 3, Mid = 8, Treb = 0.



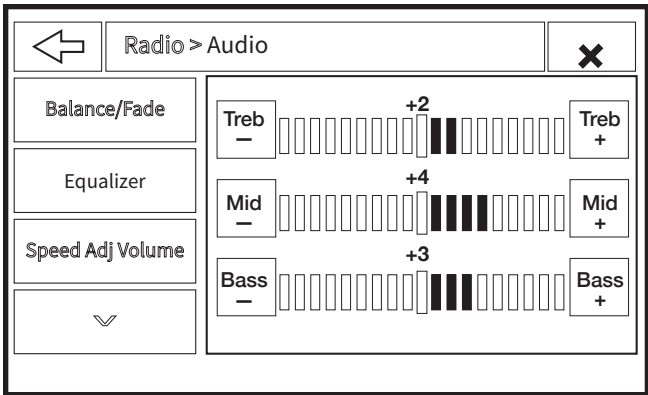

UCONNECT 3 (Example A shown)

Note that some stereos display EQ horizontally with Bass at the bottom. It is important to remember all settings must be entered in the correct order, Bass, Mid, Treb.

- 5** To program the EQ values to the vehicle settings, press the corresponding combination below. PRESS and HOLD for 3 SECONDS. Programming is complete when the horn sounds twice. Unplug ProCal SNAP and store in vehicle.

SET TIRE SIZE



BRAKE PEDAL

+

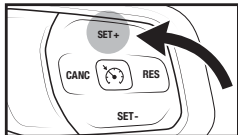

SET +

SET AXLE RATIO



BRAKE PEDAL

+

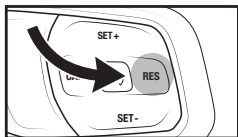

RES

SET TRANSFER  
CASE RATIO



BRAKE PEDAL

+

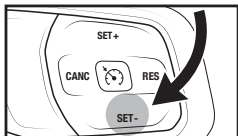

SET -

## VIEW SETTINGS

If you wish to view the current settings, you can do so on the Instrument Cluster Display. Insert the ProCal SNAP into the OBDII port. Turn the radio off and use the Instrument Cluster Display Control Buttons to navigate to AUDIO. The Instrument Cluster Display will cycle through showing the current setting for **Tire Diameter**, **Axle Ratio**, and **4Low Ratio**.

# ADDITIONAL FUNCTIONS

To use ProCal SNAP to clear DTC codes or restore your vehicle's factory settings, follow programming steps 1 and 2 then PRESS/PULL and the combinations below and HOLD for 3 SECONDS.

## CLEAR DTC CODES



BRAKE PEDAL

+

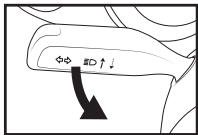

PULL HIGH BEAM

+

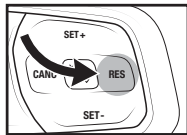

RES

## RESTORE FACTORY SETTINGS



BRAKE PEDAL

+

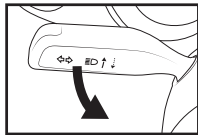

PULL HIGH BEAM

+

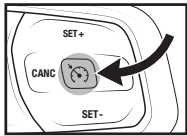

CRUISE ON/OFF

# DIAGNOSTIC CODES



**BLINKING GREEN:** ProCal SNAP ready to pair



**SOLID GREEN:** ProCal SNAP paired and ready



**SLOW PULSING ORANGE:** Waiting for vehicle ignition to be turned to RUN.



**SLOW PULSING BLUE:** Inserted into incorrect vehicle.



**FAST PULSING ORANGE:** No connection. Check that the harness is properly installed.



**FAST PULSING BLUE:** There has been an error in programming. Turn the radio off. Use the Instrument Cluster Display Control Buttons to navigate to AUDIO. Record the error message and contact AEV support with the information shown.

# TROUBLESHOOTING

**Q:** No light on the ProCal SNAP.

**A:** Contact Support.

**Q:** The light was solid green, I attempted to program something, there was no honk and now the ProCal SNAP has a fast pulsing blue light.

**A:** Turn the radio off. Use the Instrument Cluster Display Control Buttons to navigate to AUDIO. Record the error message and contact AEV support with the information shown.

**Q:** What if I don't have a factory stereo?

**A:** Contact AEV support, some aftermarket radios could still function properly. We'll be able to advise you before trying.

AEV Customer Support: **(248) 926-0256**

Email: **tech@aev-conversions.com**

# INCLUDED PARTS

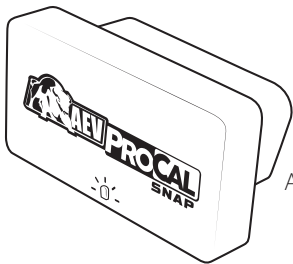

AEV PROCAL SNAP

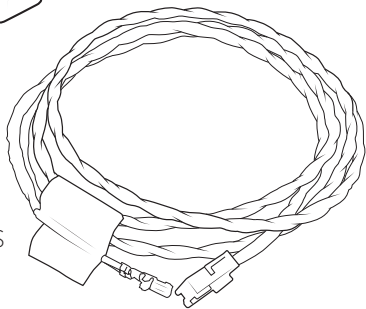

AEV JL PROCAL HARNESS



AEV-CONVERSIONS.COM